

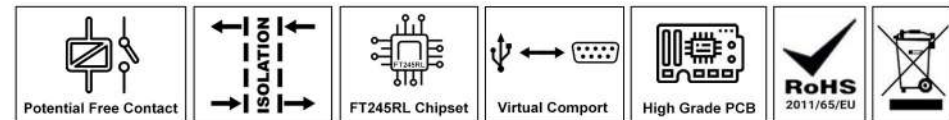

8 CHANNEL RELAY MODULE FT245RL





USB 8 Channel Relay Module FT245RL is controlled by computer USB port. The USB Relay Board is with 8 SPDT relays rated up to 7A each. You may control devices 230V / 120V (Up to 8) directly with one such relay unit. Suitable for home automation applications, hobby projects, industrial automation.

FEATURES

- 8 SPDT Relay Channels (7A 250V / 12A 120V / 10A 125VAC / 10A 28VDC).
- LED indication for relay & Power supply.
- Raspberry Pi and Beaglebone Compatible.
- High Quality PCB FR4 Grade with FPT Certified.
- USB Connector: Type B.
- Chipset: FT245RL.
- FT245RL Optical isolation and ESD protection against communication noises.
- Virtual Com Port: Serial USB Communication.
- 8 Relay LED ON / OFF and Power Status indication.
- PCB Parameters: FR4 / 1.5mm / Double Layers / HAL.
- Mounting : Din Rail / Wall Mount.
- Extra PCB openings for better voltage isolation.
- Doubled high current tracks.
- Operating temperature range: From -30 °C to +80 °C.
- Size (LxHxW): 110mm x 72.5mm x 110mm.
- Supporting .Net, Python and Lab View Applications.

- Fully integrated USB termination resistors.
- Device supplied pre-programmed with unique USB serial number.
- USB 2.0 Full Speed compatible.
- Fully integrated 1024 bit EEPROM storing, device descriptors and FIFO I/O configuration
- **Power supply requirements (Selectable during purchase):**
 5V DC / consumption - 500mA
 12V DC / consumption - 600mA
 24V DC / consumption - 400mA

Internal Block Diagram

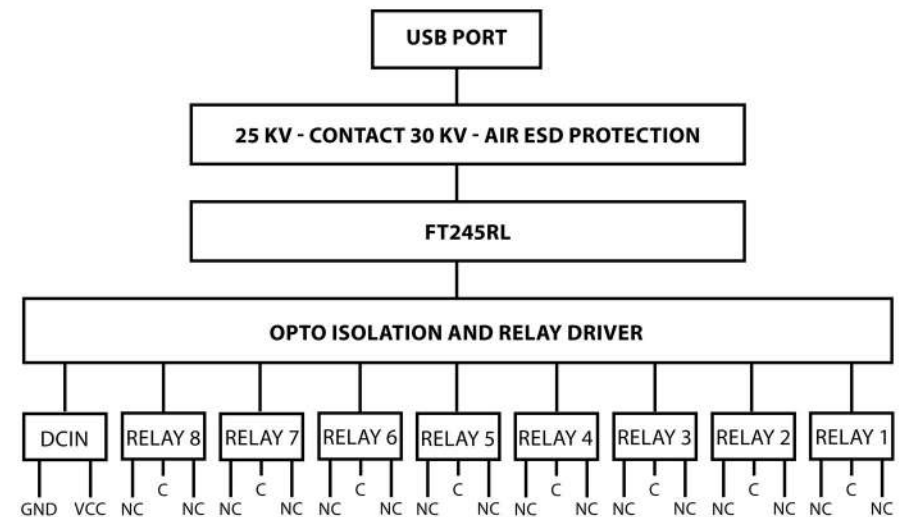



APPLICATIONS

- Home Automation
- Process Automation
- Vending Machine
- Gaming Control System
- Robotics
- Alarms
- Timers
- Remote Monitoring and Controlling.
- ATM Security System
- Aquariums Applications

CASCADING RELAY MODULES WIRING DIAGRAM

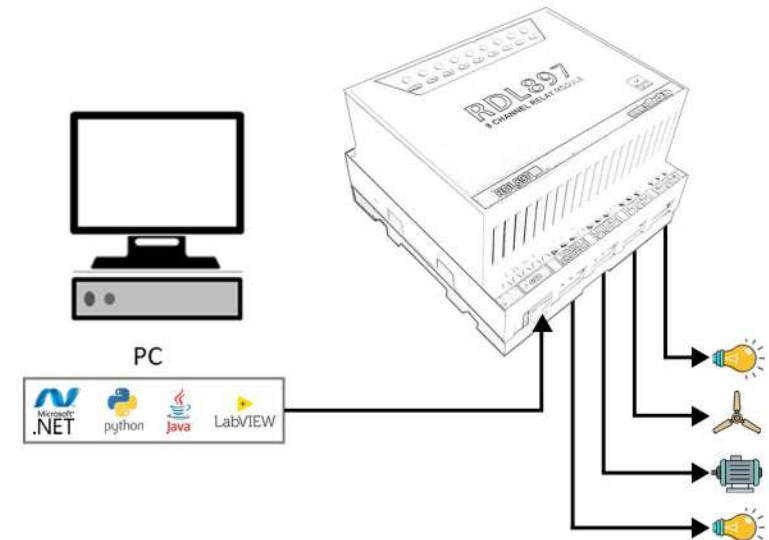
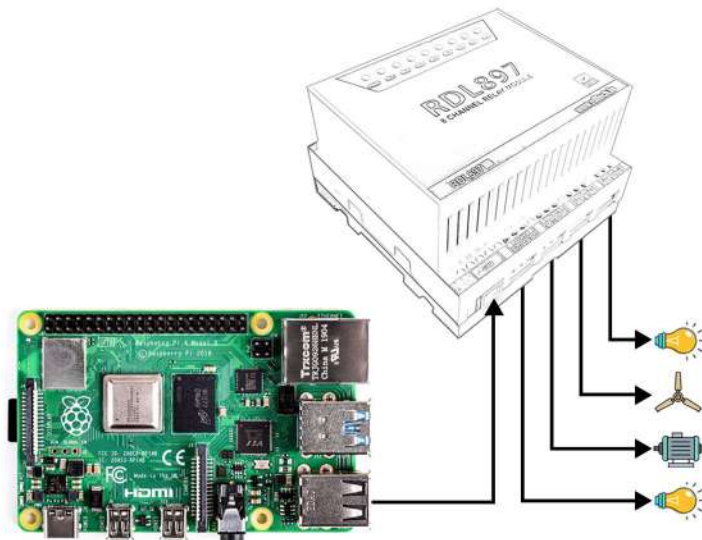
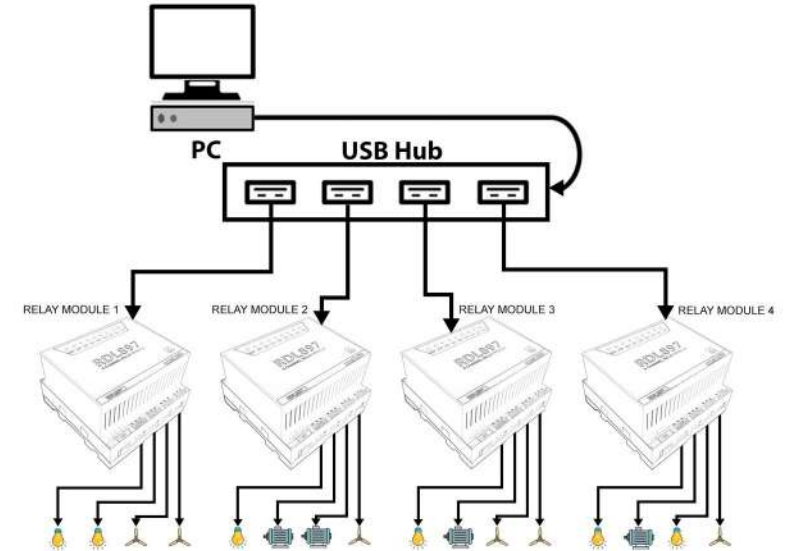

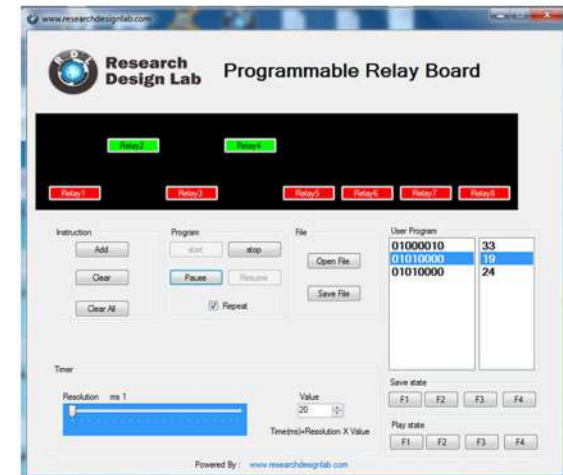
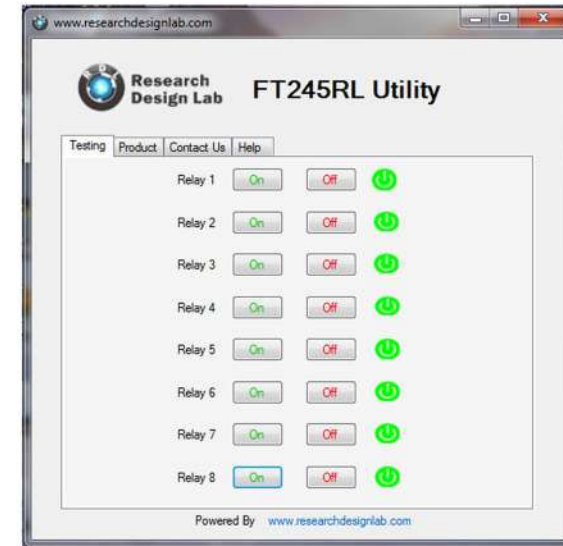
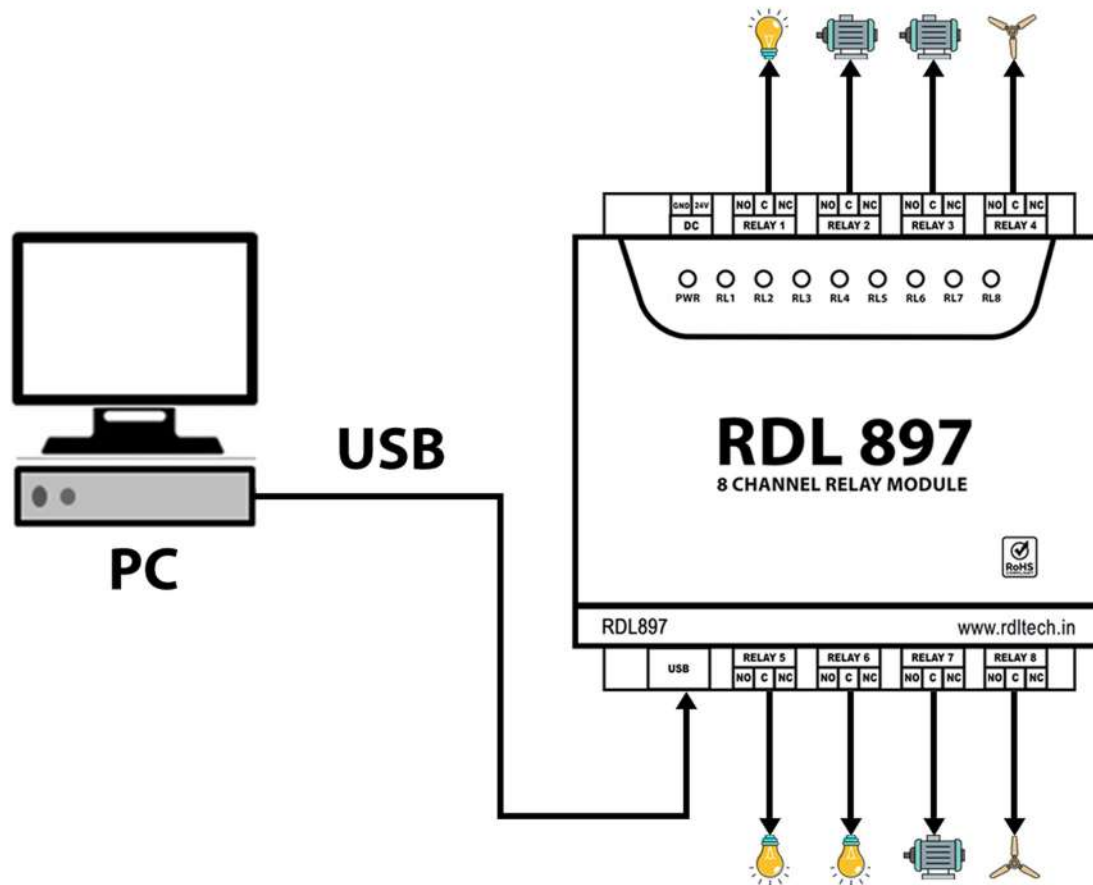

Note: For SDK Contact Support Team: support@rdltech.in



OTHER RELATED PRODUCTS



USB 4 Channel Relay Board - DIN Rail
ORDER CODE: RDL861



USB 8 Channel Relay Board - FT245RL
ORDER CODE: RDL/8RB/14/001/V2.0



8 Channel Relay Board - RS485
ORDER CODE: RDL/8RB-R/14/001/V1.0



8 Channel Ethernet Relay Board
ORDER CODE: RDL907



8 Channel Relay Board - Serial
ORDER CODE: RDL/8RB-S/14/001/V1.0



WiFi - 8 Channel Relay Board ESP32
ORDER CODE: RDL856



ORDER TABLE

| Relay | Module | Power | Enclosure | Dimension (LxHxW) | Weight |
|---------------------------------------------------------------|---------|-------|-----------|------------------------|--------|
| USB 8 Channel Relay With Enclosure (Din Rail / Wall Mount) | RDL897A | 5V | IP20 | 110mm x 72.5mm x 110mm | 275 G |
| | RDL897B | | IP65 | 280mm x 130mm x 190mm | 1.3 KG |
| | RDL897C | 12V | IP20 | 110mm x 72.5mm x 110mm | 275 G |
| | RDL897D | | IP65 | 280mm x 130mm x 190mm | 1.3 KG |
| | RDL897E | 24V | IP20 | 110mm x 72.5mm x 110mm | 275 G |
| | RDL897F | | IP65 | 280mm x 130mm x 190mm | 1.3 KG |

IP20 ENCLOSURE



IP65 ENCLOSURE





We Ship Worldwide

Our Shipping Partner



We Accept



Note:

1. Unless otherwise specified, all parameters in this datasheet were measured at 25°C and 75% humidity.
2. All index testing procedures in this datasheet are based on our company's corporate standards.
3. We offer product customization, OEM and ODM Services; please contact the sales team @ sales@rdltech.in.
4. We Ship Worldwide.
5. Specifications are subject to change without prior notice.
6. For additional information on Product and to buy online @ www.researchdesignlab.com

RDL Technologies Pvt. Ltd.

📍 5th Floor, Sahyadri Campus, Adyar, Mangaluru - 575007 | 📞 +91 8088423347 | 📞 +91 824 2988407

✉ sales@rdltech.in | 🌐 www.rdltech.in | 📺 www.youtube.com/@researchdesignlab956